

10 or 15 cm modules - black or white



🇬🇧 A strong and stable wall with four feet, incl. clips and aluminum profiles for banner mounting. Spots are optional. Can be used as double sided by ordering extra clips + aluminum profiles for the extra banners. Delivered without banner.

🇩🇪 Eine starke und stabile Messewand mit vier FüÙe, inklusive Clips und Alu-Profile für die Bannermontage. Strahler sind optional. Kann mit extra Clips + Alu-Profile für die extra Banner als doppelseitig verwendet werden. Wird ohne Banner geliefert.

🇩🇰 En stærk og stabil væg med fire fødder, inkl. klips og aluprofiler til bannermontage. Spots er tilbehør. Kan bruges som dobbeltsidet ved tilkøb af klips + aluprofiler til ophæng af ekstra banner. Leveres uden banner.

LOWER PART:

15 x 15 modules measures

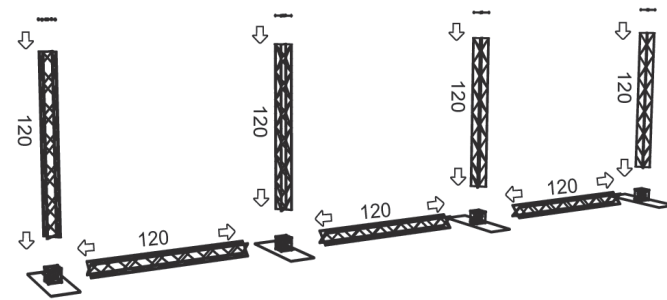
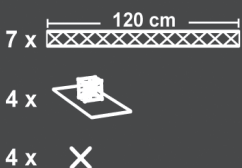

1

UPPER PART:

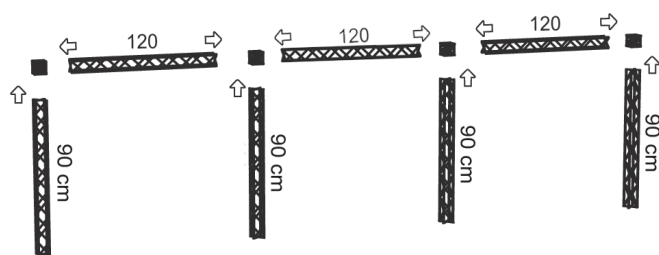
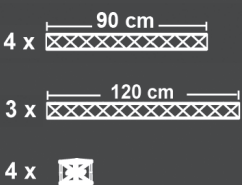

2

ASSEMBLY:

Install Banner.

Mount upper part at top of lower part.

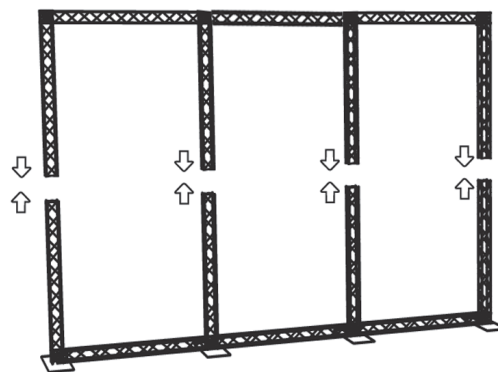

3

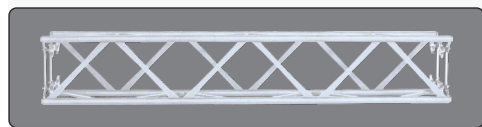

Optional spot art. 1543



Optional powerspot art. 1548



Truss 10 with 1 connection point  
Truss 15 with 4 connection points



Corner blocks 10 & 15 cm

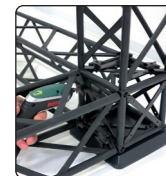

Middle bases



Truss 15 can be folded



Truss 15 can be folded



Banner with top clip



Connector cross 10 & 15 cm



Optional transport flight case - art. 9961/9962



Optional brochure holders



Model	Article	Product	Color	Print size	Total W x H x D	Weight
665	1165	Truss 10 Triple Banner wall	Black	3 pcs. 80 x 201 cm	280 x 224 x 60,5 cm	24,9 kg
685	1165w	Truss 10 Triple Banner wall	White	3 pcs. 80 x 201 cm	280 x 224 x 60,5 cm	24,9 kg
765	1765	Truss 15 Triple Banner wall	Black	3 pcs. 120 x 212 cm	424 x 246 x 60,5 cm	51,0 kg
785	1765w	Truss 15 Triple Banner wall	White	3 pcs. 120 x 212 cm	424 x 246 x 60,5 cm	51,0 kg