

 Pop-up wall made of aluminum tubes, with magnetic clip profiles. Incl. panels (for foil), magnetic tape and hanging accessories. Supplied in a black suitcase/counter with wheels. Spots, table top and PVC panel (for foil) for the counter are purchased as accessories. Excl. print.

 Pop-up Wand aus Aluminiumrohren, mit magnetische Klippprofile. Inkl. Panele mit Magnettape (für Folie) und Aufhängung. Lieferung im schwarzen Koffer/Theke mit Rollen. Als Zubehör werden Spots, Tischplatte und PVC-Platte (für Folie) für die Theke erworben. Exkl. Druck.

 Pop-up væg af alurør med magnetiske klipp profiler. Inkl. paneler med magnettape (til folie) og ophæng. Leveres i sort kuffert/counter med hjul. Spots, bordplade og PVC-panel (til folie) til counter købes som tilbehør. Ekskl. print.



3 x 3 Pop-Up Straight: Printing Panel Sizes

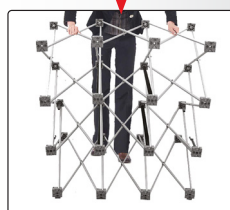
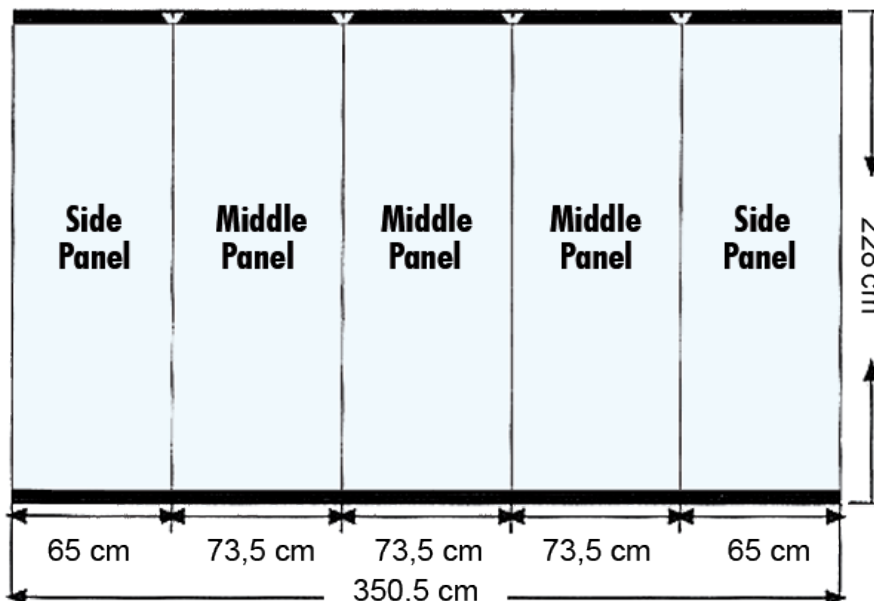

3 x 4 Pop-Up Straight: Printing Panel Sizes

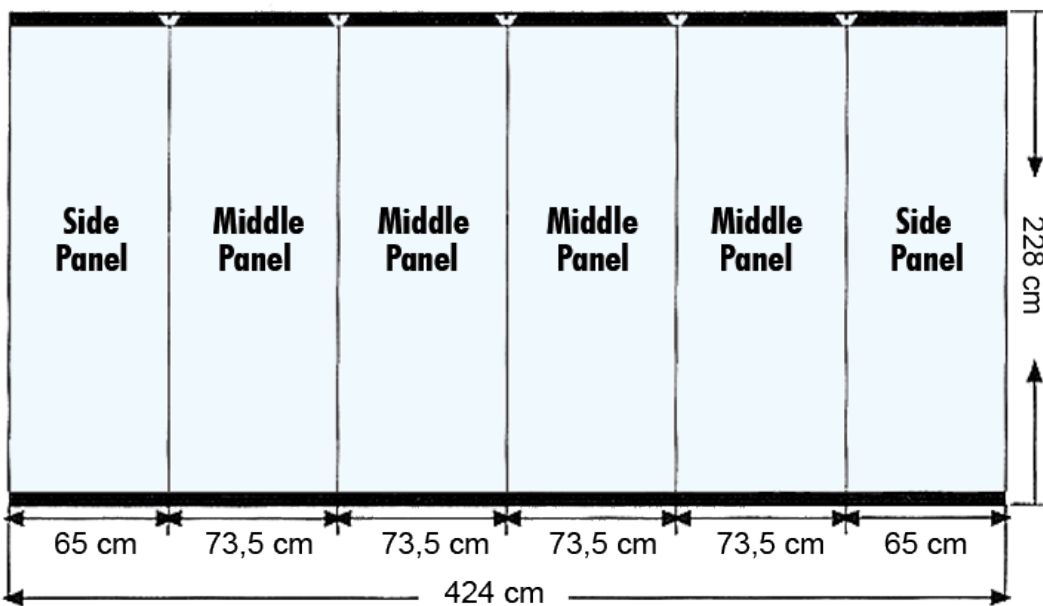

The wall is delivered in plastic hard case with wheels.

Optional
Use the hard case as a counter:

Top plate
art. 4538
Counter panel for foil
art. 4537



Foldable top plate in plastic 70 x 50 cm:
Art. 4538



Model	Article	Product	Print height x width	Color	Total W x H	Package size and weight	Pallet size and quantity
721	4433	Straight 3 sections	228 cm x 2 x 65 + 3 x 73,5 cm	Grey	280 x 228 cm	41 x 92 x 60 cm 25 kg	85 x 125 x 200 cm 6 pcs.
721	4434	Straight 4 sections	228 cm x 2 x 65 + 4 x 73,5 cm	Grey	354 x 228 cm	41 x 92 x 60 cm 29 kg	85 x 125 x 200 cm 6 pcs.
	4538	Top plate for counter	70 x 1,2 x 50 cm	Black		73 x 26 x 4 cm 2 kg	
	4537	Panel for counter	162 x 80 cm	Black		25 x 80 cm 1 kg	
706	4513	Spot 150 W with 340 cm cable		Black	13,5 x 45 cm	6 x 15 x 50 cm 1 kg	85 x 120 x 120 cm 200 pcs.
702	4500	2 LED spots with fittings and 275 + 245 cm cable		Black	13,5 x 45 cm		
702	4501	2 LED spots with fittings and 275 + 245 cm cable		White	13,5 x 45 cm		



The Pop-up presentation walls are delivered in a cart board box.
Do not open the box with a knife or sizzers!!! You might damage the suitcase.



In the packaging you find the transportation suitcase.



On the backside of the suitcase there is a grip which you can pull out, by tilting the suitcase you can easily roll the suitcase.



Open the suitcase by turning the openers on both sides
Content see image 6.



1x Pop-up wall
PVC sheets (3x3=5 pieces 4x3=6 pieces)
Connection peices (3x3=18 pieces 4x3=21 pieces)
1x Roll self adhesive magnetic tape
Transportation suitcase
hanging block (3x3=6 pieces 4x3=7 pieces)
Hanging strips with slot (3x3=5 pieces 4x3=6 pieces)
Hanging strips with cut-out piece (3x3=5 pieces 4x3=6 pieces)

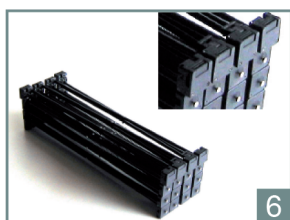

Lay down the Pop-up in such a way that the side with the 4 or 5* thick blocks on a row is on top, this will be the front side.
*4 or 5 depending on 3x3 or 3x4



Pull up the system half way, now you can easily mount the other pieces.



This is a thick block on the top side.

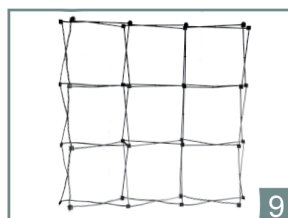

Pull up the system so that it unfolds completely.



These are the hanging strips with slot and with cut-out piece.



The hanging strip with slot comes on top of the PVC sheet, the hanging strip with cut-out piece on the bottom.



The hanging strips with slot and with cut-out piece are delivered in 2 lengths. The short ones are for the outside sheets of the wall (the curved sheets).



Connection pieces



First place a conection piece on the bottom.



Slide the block on to the bottom block of the pop-up with the metal pin.



Take another connection piece and slide the point into the top block of the pop-up.



Slide the bottom block of the connection piece on the block below of the pop-up.



Slide the middle connection piece into the top connection piece block and the bottom connection piece block. Now slide the block onto the block with the metal pin of the pop-up.



One standing piece is now complete, repeat step 26 till 30 for the other standing pieces.



Attention: the PVC sheets are oversized!!!
And have to be cut to the right size. The breadth of the hanging strip determines the breadth of the image.

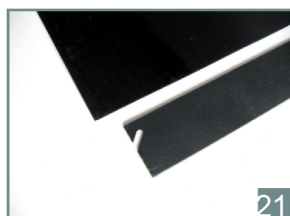

Here you see clearly that the PVC sheet is wider than the hanging strip. This is done to make mounting the full-colour-print easier. The length you should measure in the system.



Mount the full-colour-print on the PVC sheet.

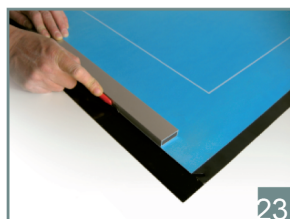

After mounting cut away the unnecessary strips.

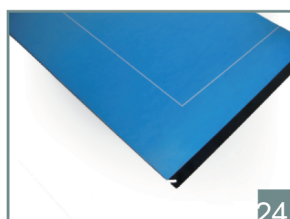

Now that the full-colour-print is mounted and cut, the sheet has the breadth of the particular hanging strip.

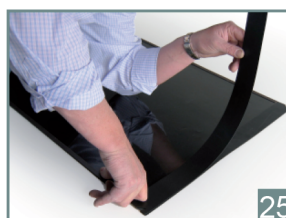

The hanging strip with slot you put on the topside of the sheet, the hanging strip with cut-out piece on the bottomside. Mounting is done by the self adhesive strip.

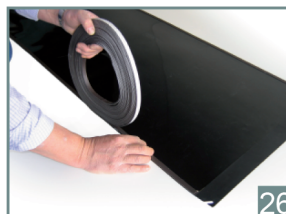

Now mount on the backside of sheet the self adhesive magnetic strip on the long sides of the sheet.
Now the sheet is ready.



Hang the PVC sheet in the hanging blocks on the top-side.



The sheet stays in place by means of the magnetic strips and the hanging strips. Repeat the procedure for the other sheets.



Spots are optional

The system is delivered with a 3-pole plug, possibly you have to replace this one with another plug.

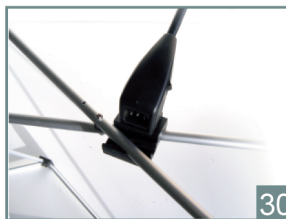

Spots are optional

You can also mount the halogen lamps on the legs of the system as shown. The light will be closer to you presentation.

Carrying capacity for hardcase/counter: 30 kg



Print measure for hardcase/counter

162 cm (oversized panel length)

157 cm (final length after cut down)

75,5 cm (final height)

80,0 cm (oversize)

A

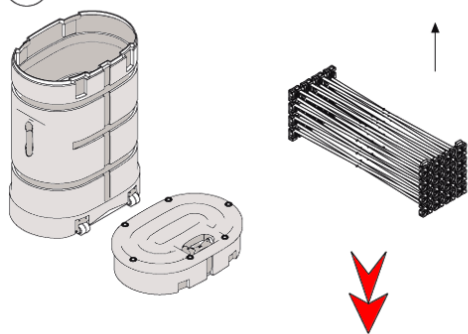

Instruction of assembly / Montageanleitung

Side panel (oversize) 231 cm



GB Side panel thickness 0,4 mm
DE Seitenpaneel Stärke 0,4 mm

65 cm top strap



GB Black strap with slot and tape (0,8 mm) for side panels
DE Schwarzer PVC-Streifen mit Schlitz und Klebeband (0,8 mm) für Seitenpaneel

65 cm bottom strap



GB Black strap with tape (0,8 mm) for side panels
DE Schwarzer PVC-Streifen mit Klebeband (0,8 mm) für Seitenpaneel

Middle panel (oversize) 231 cm



GB Middle panel thickness 0,6 mm
DE Mittleres Paneel Stärke 0,6 mm

73,5 cm top strap



GB Black strap with slot and tape (2 mm) for middle panels
DE Schwarzer PVC-Streifen mit Schlitz und Klebeband (2 mm) für Mittlere Paneel

73,5 cm bottom strap



GB Black strap with tape (2 mm) for middle panels
DE Schwarzer PVC-Streifen mit Klebeband (2 mm) für Mittlere Paneel

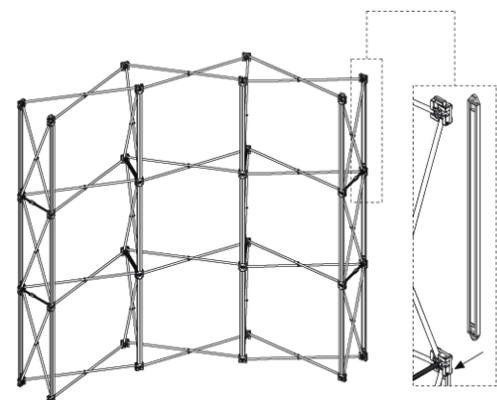

Final dimensions after trimming of print / Abmessung nach dem Zuschneid des Druckes

B

65 cm 73,5 cm 73,5 cm 73,5 cm 65 cm

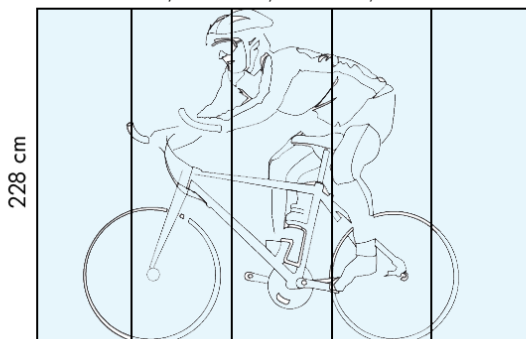

	Thin panel 0,4 mm Schmales Paneel	Thick panel 0,6 mm Breites Paneel
3 x 3 Pop-up	2 pcs. / Stück	3 pcs. / Stück
3 x 4 Pop-up	2 pcs. / Stück	4 pcs. / Stück

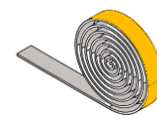

GB Roll with magnetic tape

DE Rolle mit magnetischem Klebeband

Oversized panels mounted with print / Paneel in Übermaß mit Druck montiert

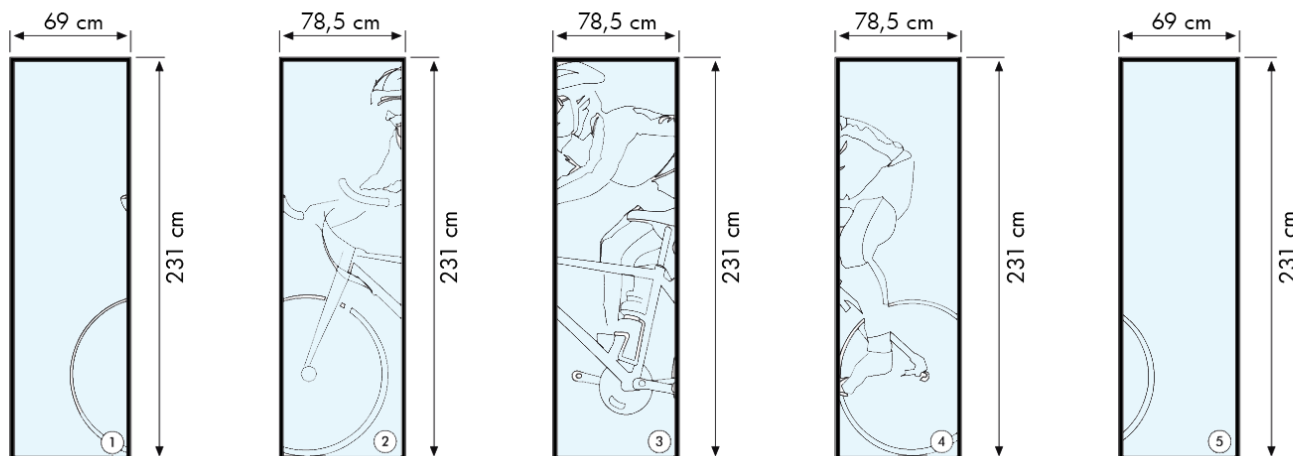

GB Side panel
Thickness 0,4 mm

DE Seitenpaneel
Stärke 0,4 mm

GB Middle panel
Thickness 0,6 mm

DE Mittleres Paneel
Stärke 0,6 mm

GB Middle panel
Thickness 0,6 mm

DE Mittleres Paneel
Stärke 0,6 mm

GB Middle panel
Thickness 0,6 mm

DE Mittleres Paneel
Stärke 0,6 mm

GB Side panel
Thickness 0,4 mm

DE Seitenpaneel
Stärke 0,4 mm

C Cutting of side panels (2 pcs. 0,4 mm) / Zuschnitt der Seitenpaneele (2 Stück 0,4 mm)

GB: Cut the right measurement with tools carefully not to damage the printing.

DE: Um den Werbeaufdruck auf dem PVC Paneel nicht zu beschädigen, vorsichtig auf Maß zuschneiden.

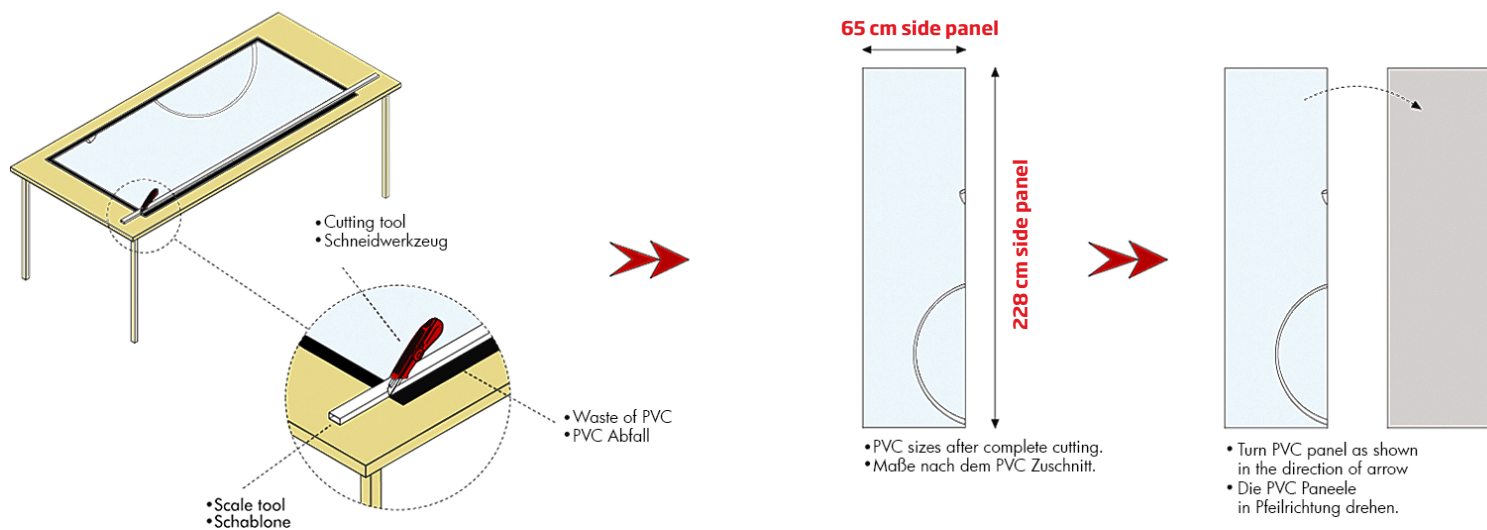

D Please fixate as shown / Bitte fixieren gemäß Abbildung

GB: Fix **thin PVC straps (0,8 mm)** with and without slot as shown - cut form over PVC strap with slot - by a cutting tool off from PVC panel.

DE: Die **dünnen PVC Streifen (0,8 mm)** mit und ohne den Schlitz, gemäß Beschreibung auf den jeweiligen PVC Paneelen kleben.

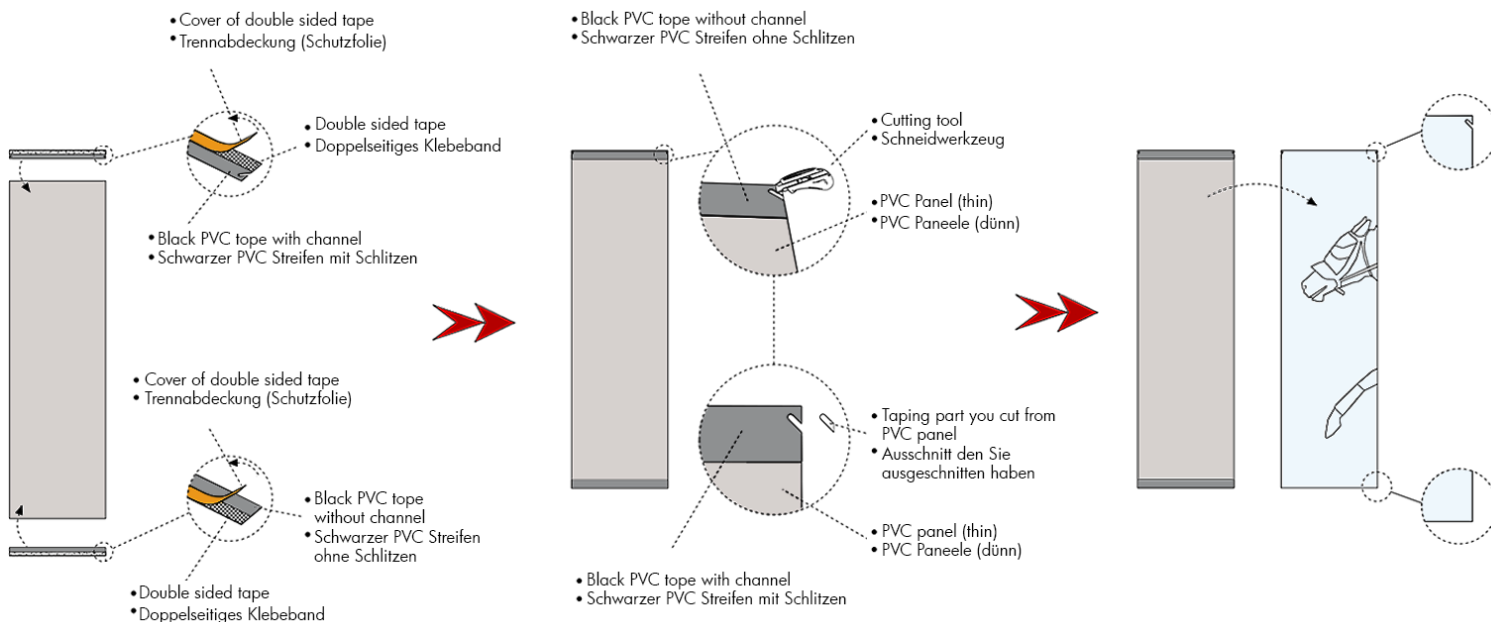

E Cutting of **middle panels** (3 or 4 pcs. 0,6 mm) / **Zuschnitt der Mittleren Paneele** (3 oder 4 Stück 0,6 mm)

GB: Cut PVC on right measurement with tools carefully not to damage the printing.

DE: Um den Werbeaufdruck auf dem PVC Paneel nicht zu beschädigen, vorsichtig auf Maß zuschneiden.

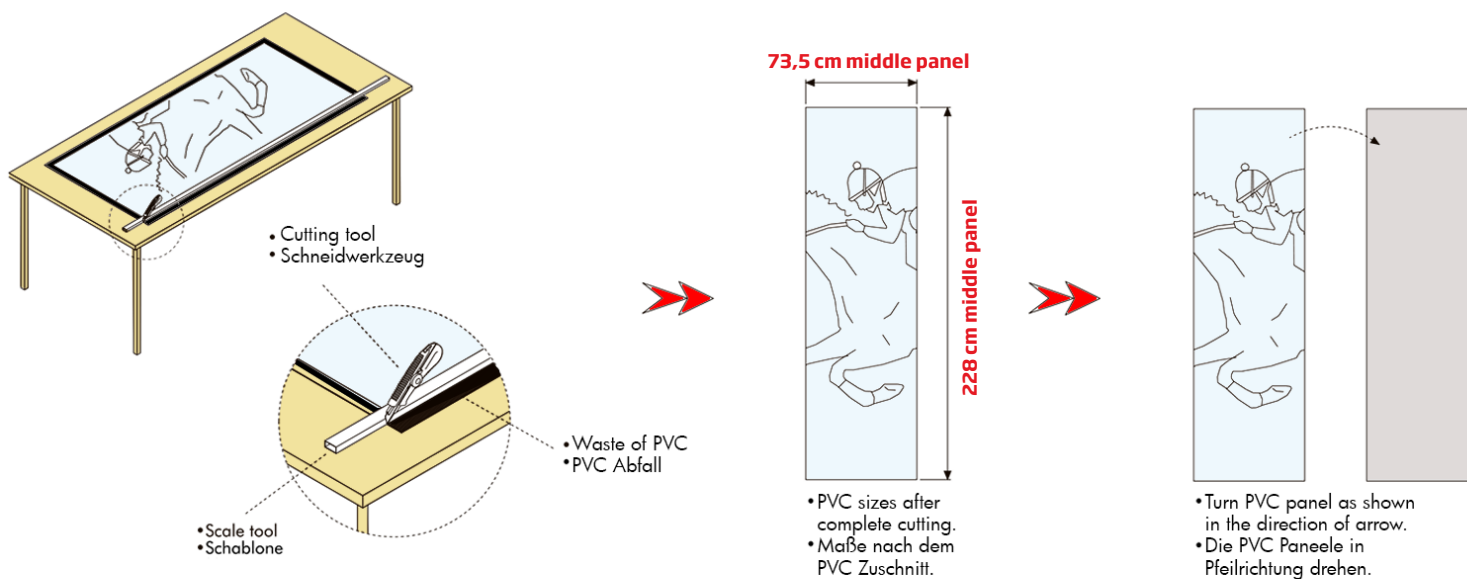

F Please fixate as shown / Bitte fixieren gemäß Abbildung

GB: Fix **thick PVC straps (2 mm)** with an without slot as shown, cut form over PVC strap with slot by cutting tool off from PVC panel.

DE: Die **dicken PVC Streifen (2 mm)** mit und ohne den Schlitz, gemäß Beschreibung auf den jeweiligen PVC Paneelen kleben.

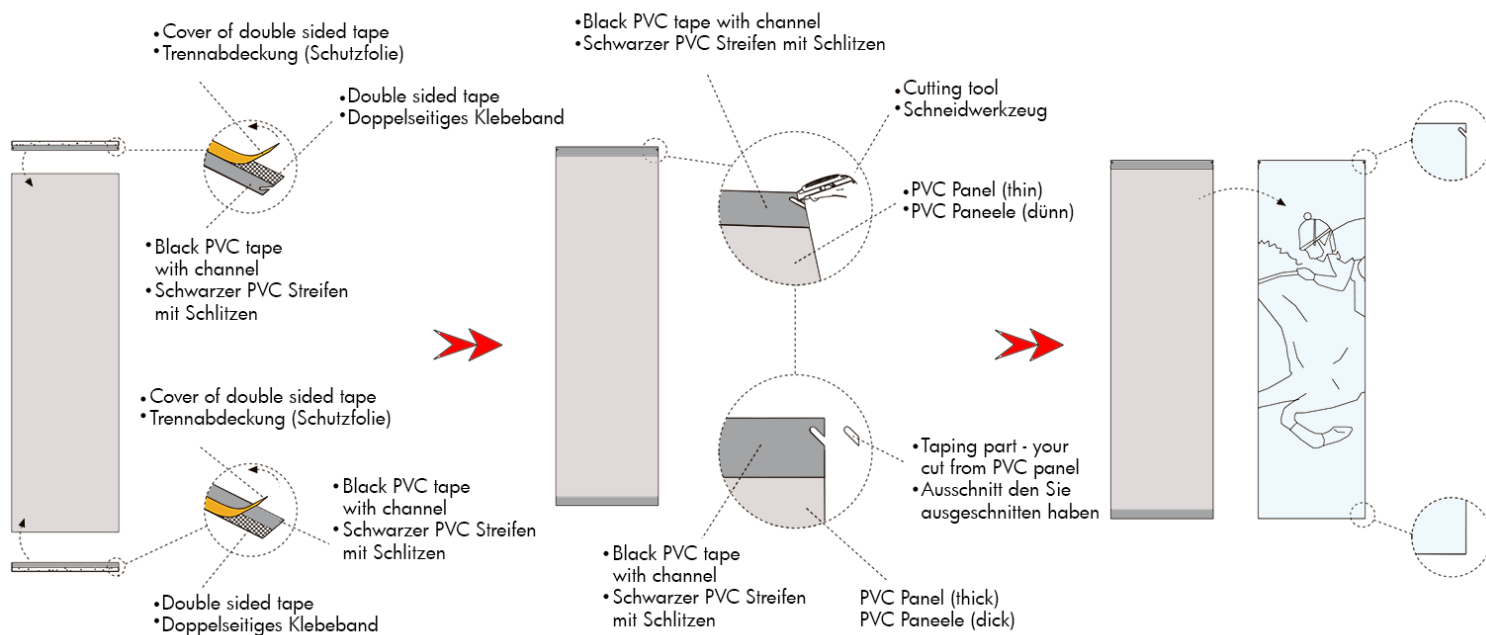

G Apply magnetic sticker / Befestigung vom magnetischen Klebeband

GB: Step: Fixate magnetic band giving som free space from up and side. Apply this procedure for the other panels too.

DE: Bei der Befestigung des magnetischen Klebebandes oben und unten, sowie zur Seite Abstand halten gemäß Abbildung.

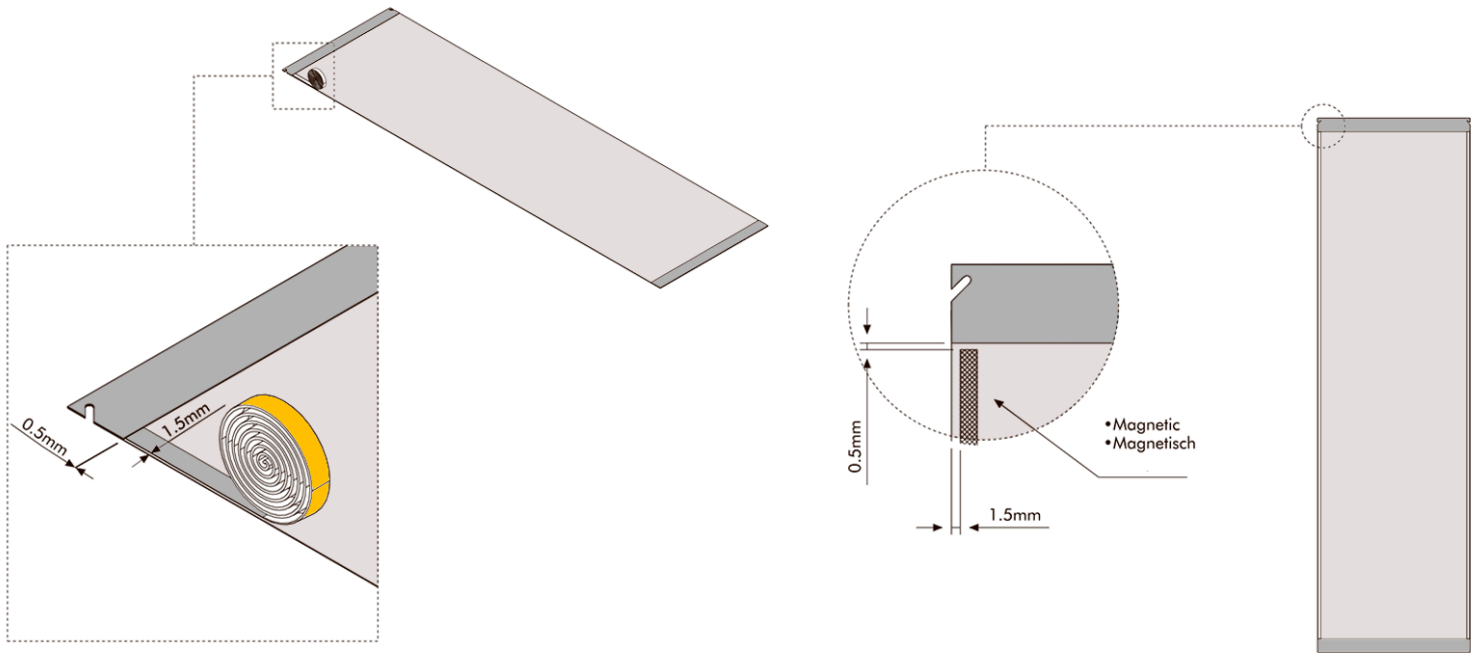

H Apply the panels / Montage der Paneele

