

10 or 15 cm modules - black or white

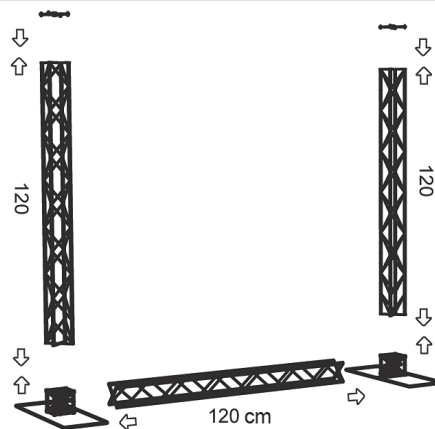

LOWER PART:

15 x 15  
modules  
measures

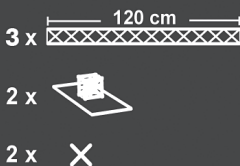

1

UPPER PART:

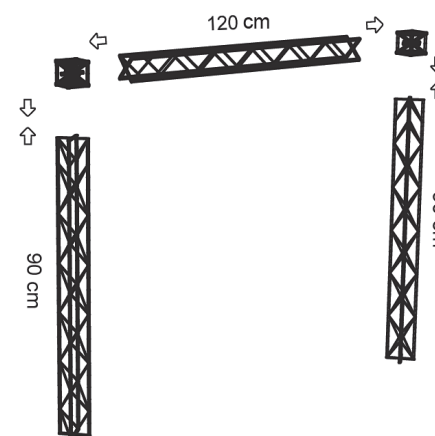
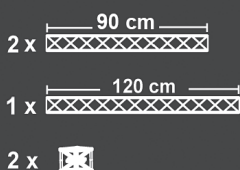

2

ASSEMBLY:

Install Banner.

Mount upper part at  
top of lower part.

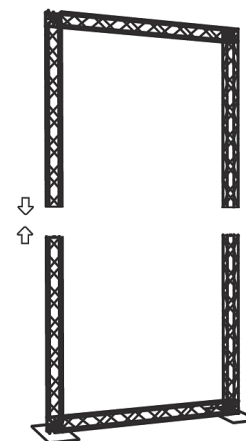

3

🇩🇪 A strong and stable wall with two feet, incl. clips and aluminum profiles for banner mounting. Spots are optional. Can be used as double sided by ordering extra clips + aluminum profiles for the extra banners. Delivered without banner.

🇩🇪 Eine starke und stabile Messewand mit zwei FüÙe, inklusive Clips und Alu-Profile für die Bannermontierung. Strahler sind optional. Kann mit extra Clips + Alu-Profile für die extra Banner als doppelseitig verwendet werden. Wird ohne Banner geliefert.

🇩🇪 En stærk og stabil væg med to fødder, inkl. klips og aluprofiler til bannermontering. Spots er tilbehør. Kan bruges som dobbeltsidet ved tilkøb af klips + aluprofiler til ophæng af ekstra banner. Leveres uden banner.

Optional spot  
art. 1543



Optional powerspot  
art. 1548



Truss 10 with 1 connection point  
Truss 15 with 4 connection points



Corner blocks  
10 & 15 cm

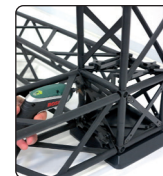

Middle bases



Truss 15 can be folded



Truss 15 can be folded



Banner with  
top clip



Connector cross  
10 & 15 cm



Optional transport flight case - art. 9961/9962



Optional brochure holders



Model	Article	Product	Color	Print size	Total W x H x D	Weight
663	1163	Truss 10 Single Banner wall	Black	80 x 201 cm	105 x 224 x 60,5 cm	11,1 kg
683	1163w	Truss 10 Single Banner wall	White	80 x 201 cm	105 x 224 x 60,5 cm	11,1 kg
763	1763	Truss 15 Single Banner wall	Black	120 x 212 cm	155 x 246 x 60,5 cm	24,0 kg
783	1763w	Truss 15 Single Banner wall	White	120 x 212 cm	155 x 246 x 60,5 cm	24,0 kg



**Banner size:** The banner size for CROWN Truss must have the same size as the inner measure between the modules. Approx. 3 cm in top and bottom of the banner must be wrapped around the alu profile and are thus not visible. The alu profile is mounted with tape.

**Bannermaße:** Banner Größe für CROWN Truss muß das selbe als den Innenmaßen schwi-schen die Module sein. Etwa 3 cm vom Banner oben und unten wird um die Aluleiste gewickelt und ist hiermit nicht sichtbar. Die Aluleiste ist mit Klebeband montiert.

**Bannermål:** Bannermål til CROWN Truss skal være det samme som det indvendige mål på din opstilling. Ca. 3 cm i top og bund af banneret vikles rundt om alulisten, og bliver dermed ikke synligt. Alulisten er monteret med tape.

### Banner material:

We recommend  
250-320 g  
polyester  
or similar

Mounting of banner  
on alu profile with tape



Top clip: 3 pcs. per banner metre

Aluprofile 3 x 12 mm (x length) with tape ▼



Bottom clip: 3 pcs. per banner meter



## 15 x 15 cm modules

- A modular truss system 15 x 15 cm made in strong and durable materials - aluminum, steel and composite.
- Black or white
- 4 screws for connecting
- The modules can be folded so that they do not take up much space during transport or storage

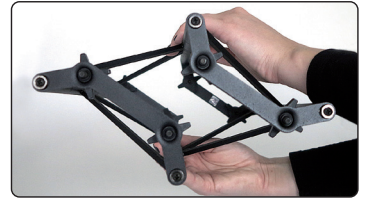
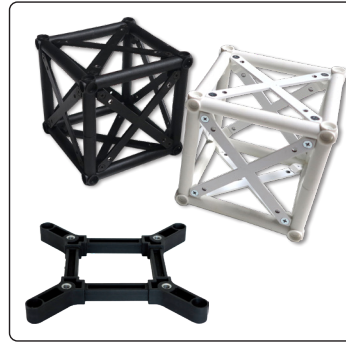

## 10 x 10 cm modules

- A modular truss system 10 x 10 cm made in strong and durable materials - aluminum, steel and composite.
- Black or white
- 1 screw for connecting - for faster assembly
- Not foldable



## Black bases

- Choose between 3 different bases for 10 cm or 15 cm modules for indoor use
- Outdoor base for 15 cm modules only

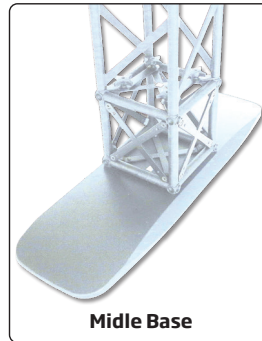
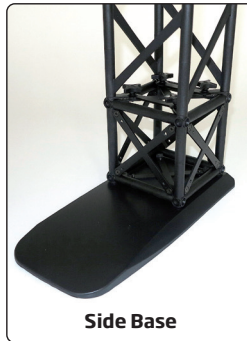
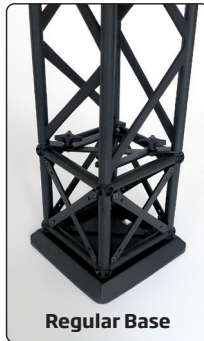

## White bases

- Choose between 3 different bases for 10 cm or 15 cm modules for indoor use

## Mounting

- Very easy to assemble and disassemble
- Use a small Bosch IXO screwdriver (or similar)

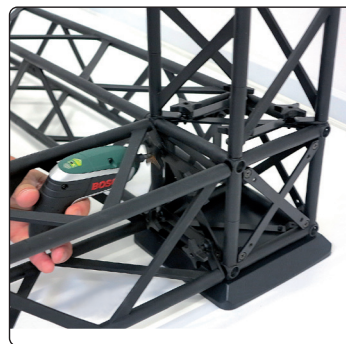

## Banner & accessories

- Mount the banner on the aluminum profile with tape (incl.) and roll it once or twice
- Attach the top- and bottom clips to the profile with banner and hang it on the stand
- Finally mount the accessories

