

10 or 15 cm modules - black or white



SIDE 1

15 x 15
modules
measures

14 x

2 x

4 x

4 x

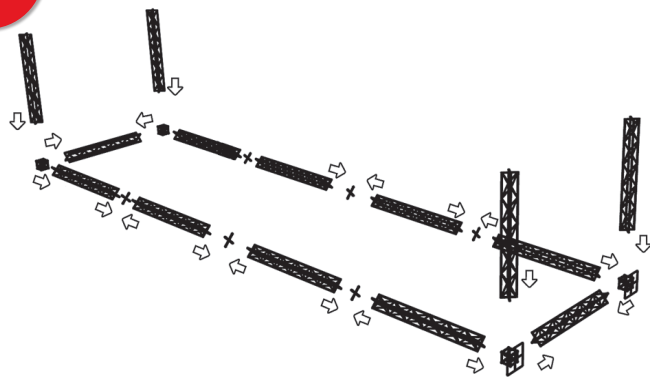

1

SIDE 2

10 x

2 x

4 x

4 x

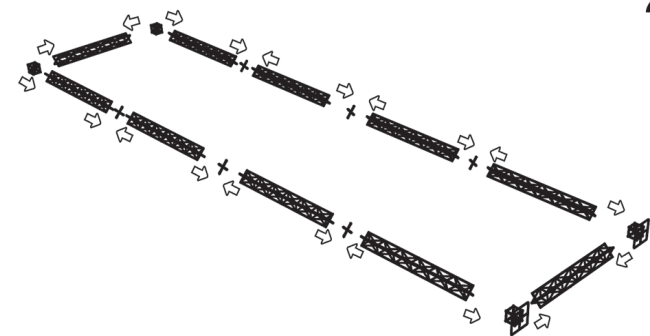

2

ASSEMBLY

Mount side 2 on top of side 1.

Install Banners before raising tower.

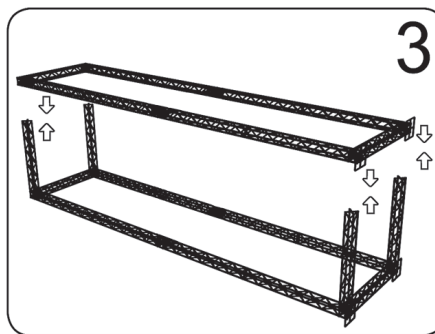

3

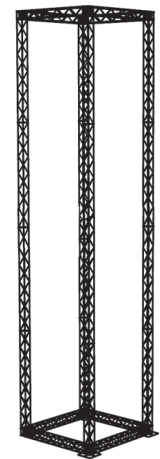

4

A strong and stable tower with four feet, incl. clips and aluminum profiles for banner mounting. Spots are optional. Delivered without banner.

Eine starke und stabile Turm mit vier Füße, inkl. Clips und Alu-Profilen für die Bannermontierung. Strahler sind optional. Wird ohne Banner geliefert.

Et stærkt og stabilt tårn med fire fødder, inkl. klips og aluprofiler til bannermontering. Spots er tilbehør. Leveres uden banner.

Optional spot
art. 1543



Optional powerspot
art. 1548



Truss 10 with 1 connection point
Truss 15 with 4 connection points



Corner blocks
10 & 15 cm

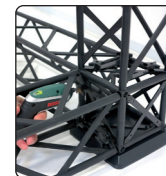

Regular bases



Truss 15 can be folded



Truss 15 can be folded



Banner with
top clip



Connector cross
10 & 15 cm



Optional transport flight case - art. 9961/9962



Optional brochure holders



Model	Article	Product	Modules	Color	Print size	Total W x H x D	Weight
667	1167	Truss 10 Tower	10 x 10 cm	Black	4 pcs. 80 x 302 cm	105 x 325 x 105 cm	31,9 kg
687	1167w	Truss 10 Tower	10 x 10 cm	White	4 pcs. 80 x 302 cm	105 x 325 x 105 cm	31,9 kg
767	1767	Truss 15 Tower	15 x 15 cm	Black	4 pcs. 120 x 485 cm	154 x 517 x 154 cm	79,0 kg
787	1767w	Truss 15 Tower	15 x 15 cm	White	4 pcs. 120 x 485 cm	154 x 517 x 154 cm	79,0 kg



Banner size: The banner size for CROWN Truss must have the same size as the inner measure between the modules. Approx. 3 cm in top and bottom of the banner must be wrapped around the alu profile and are thus not visible. The alu profile is mounted with tape.

Bannermaße: Banner Größe für CROWN Truss muß das selbe als den Innenmaßen schwi-schen die Module sein. Etwa 3 cm vom Banner oben und unten wird um die Aluleiste gewickelt und ist hiermit nicht sichtbar. Die Aluleiste ist mit Klebeband montiert.

Bannermål: Bannermål til CROWN Truss skal være det samme som det indvendige mål på din opstilling. Ca. 3 cm i top og bund af banneret vikles rundt om alulisten, og bliver dermed ikke synligt. Alulisten er monteret med tape.

Banner material:

We recommend
250-320 g
polyester
or similar

Mounting of banner
on alu profile with tape



Top clip: 3 pcs. per banner metre

Aluprofile 3 x 12 mm (x length) with tape ▼



Bottom clip: 3 pcs. per banner meter



15 x 15 cm modules

- A modular truss system 15 x 15 cm made in strong and durable materials - aluminum, steel and composite.
- Black or white
- 4 screws for connecting
- The modules can be folded so that they do not take up much space during transport or storage

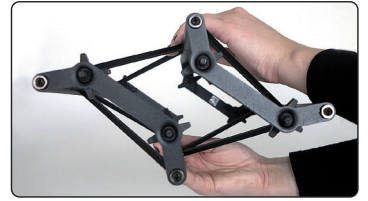

10 x 10 cm modules

- A modular truss system 10 x 10 cm made in strong and durable materials - aluminum, steel and composite.
- Black or white
- 1 screw for connecting - for faster assembly
- Not foldable

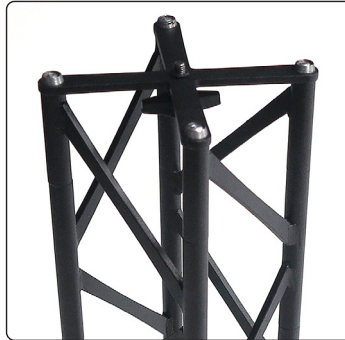

Black bases

- Choose between 3 different bases for 10 cm or 15 cm modules for indoor use
- Outdoor base for 15 cm modules only

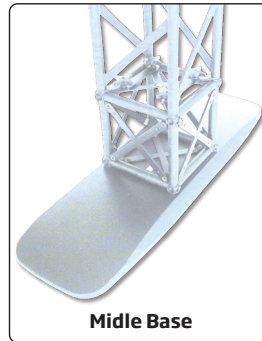
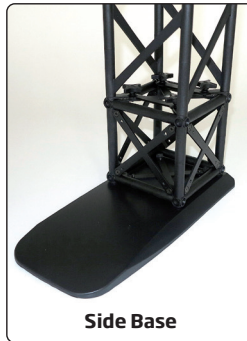
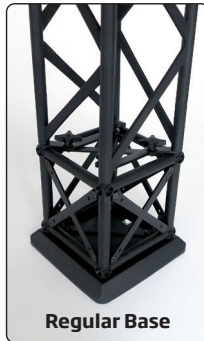

White bases

- Choose between 3 different bases for 10 cm or 15 cm modules for indoor use

Mounting

- Very easy to assemble and disassemble
- Use a small Bosch IXO screwdriver (or similar)

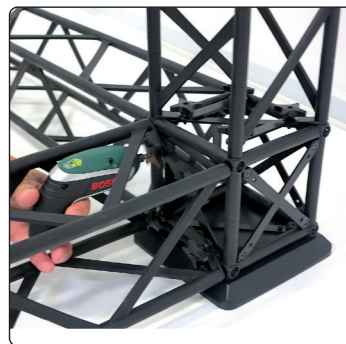

Banner & accessories

- Mount the banner on the aluminum profile with tape (incl.) and roll it once or twice
- Attach the top- and bottom clips to the profile with banner and hang it on the stand
- Finally mount the accessories

