

ART. 6017
SINGLE

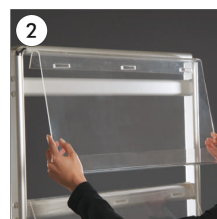

ART. 6023
DOUBLE

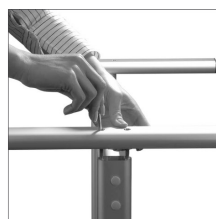
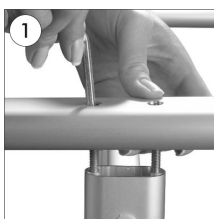
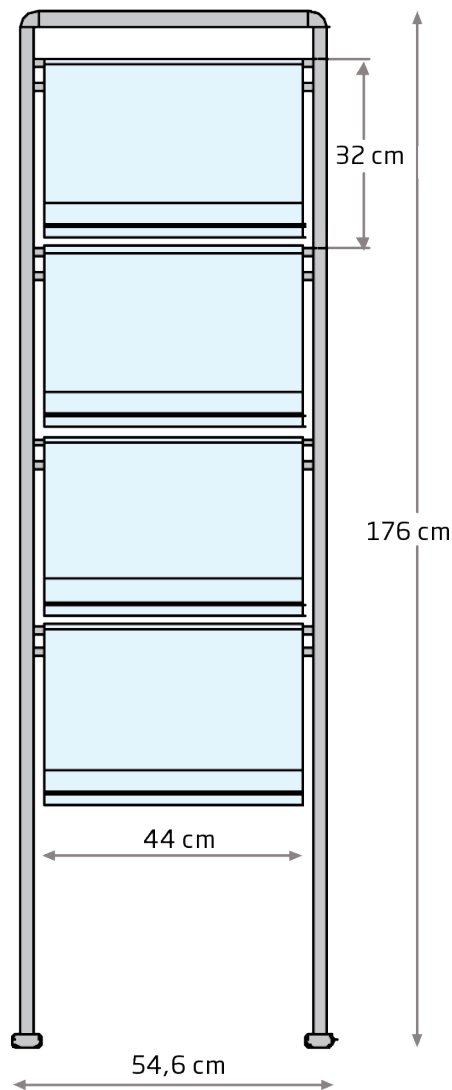
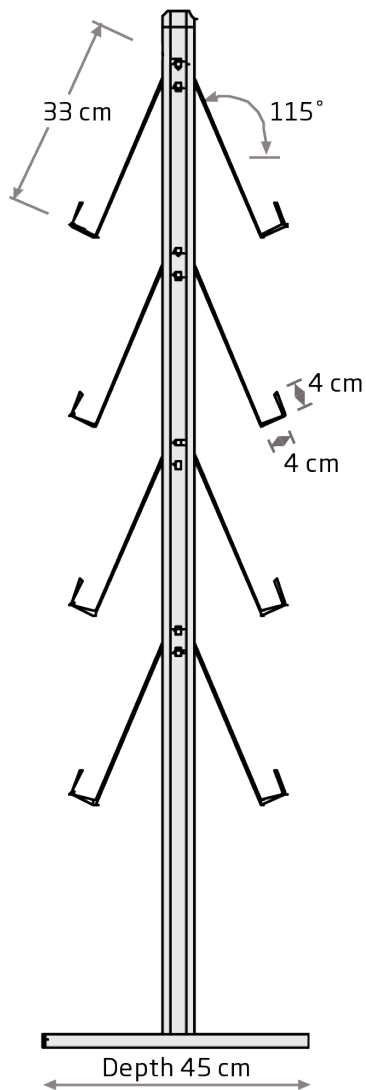

- Fix the bottom feet to the legs on both sides by allen key.
- Fixieren Sie die Fussprofile an die Seitenprofile fest.

- Place the acrylic shelves from bottom to top.
- Beginnend von unten sind die Acrylablagen an Querstreben anzuhängen.

Single or double sided aluminum brochure stand with 4 mm acrylic transparent shelves for 8 or 16 pcs. of A4 brochures.

Ein- oder doppelseitiger Aluminium Ständer. Fächer aus 4 mm Acryl für 8 oder 16 Stück A4 Prospekte.

Enkelt- eller dobbeltsidet aluminiums brochurestander med 4 mm akrylhylder til 8 eller 16 stk. A4-brochurer.

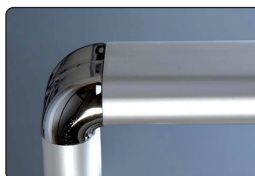
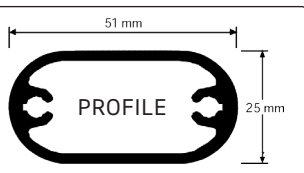

Model	Article	Capacity	Colour	Total W x H	Package size and weight	Pallet size and quantity
819	6017	Single sided: 8 x A4	Alu / acrylic	54,6 x 176 cm	55 x 177 x 7 cm 9,5 kg	80 x 120 x 220 cm 12 pcs.
819	6023	Double sided: 16 x A4	Alu / acrylic	54,6 x 176 cm	56 x 178 x 8 cm 16 kg	80 x 120 x 220 cm 15 pcs.