



**FOR INDOOR USE!**



 Anodized aluminum stand with 2 pcs. banner suspension. Delivered without banner.

 Eloxiertes Aluminium Ständer mit 2 Stück Bannerschienen. Wird ohne Banner geliefert.

 Eloxeret aluminiumsstander med 2 stk. bannerskinner. Leveres uden banner.

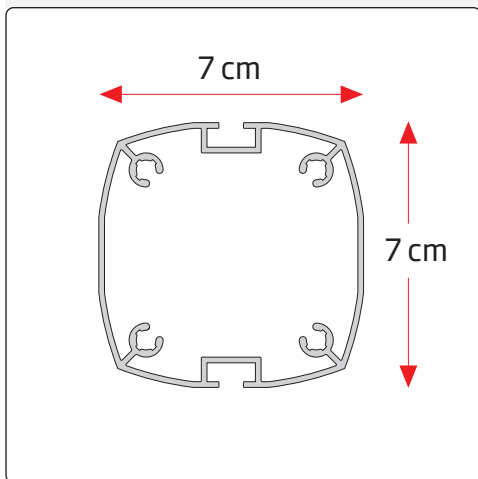
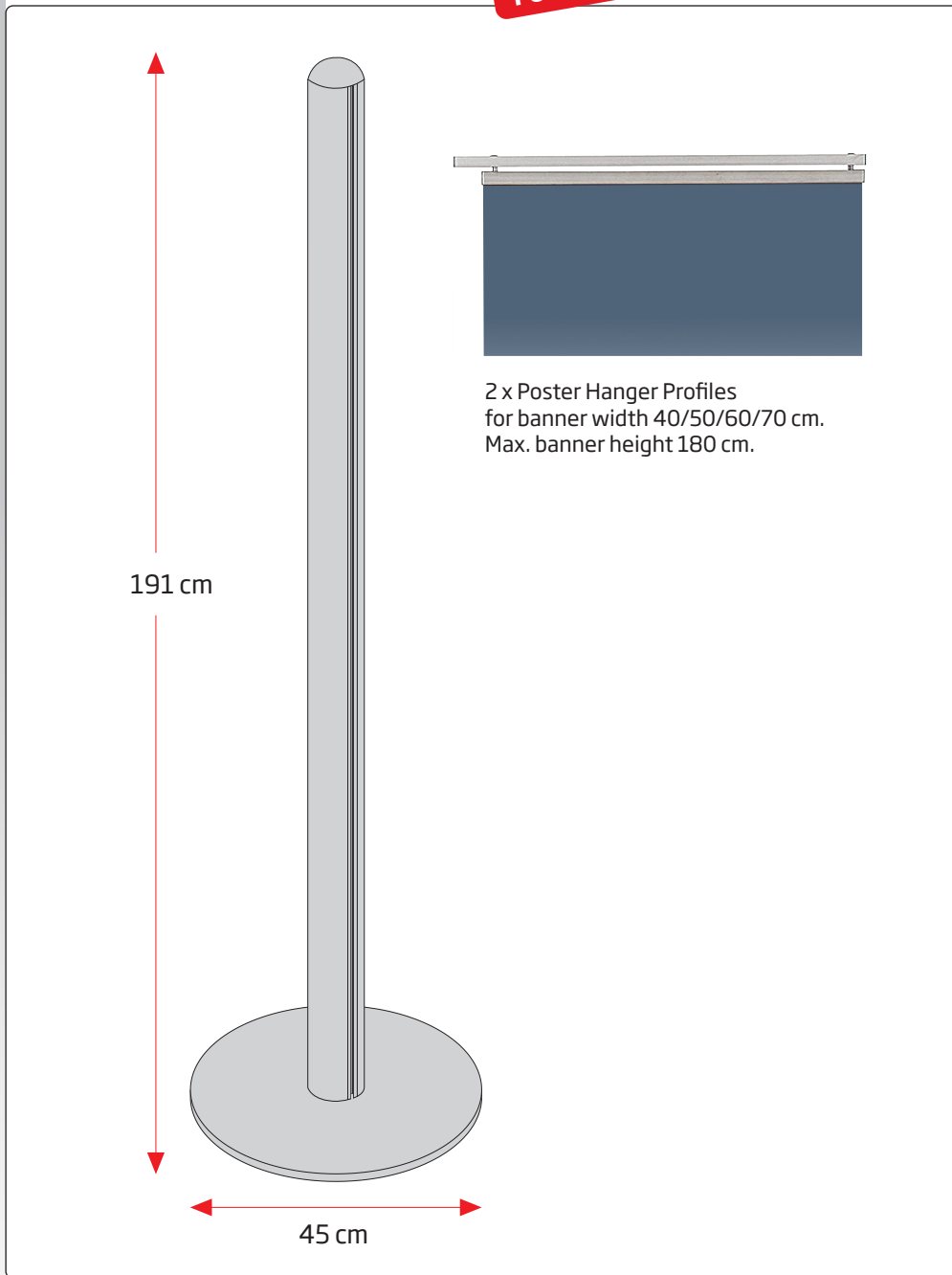

Model	Article	Banner width	Color	Total W x H	Base	Weight	Pallet size and quantity
917	<b>2862</b>	2 pcs. 40 cm suspensions	Alu/silver	98 x 190 cm	Ø 45 cm	16 kg	80 x 120 x 220 cm 20 pcs.
917	<b>2863</b>	2 pcs. 50 cm suspensions	Alu/silver	118 x 190 cm	Ø 45 cm	17 kg	80 x 120 x 220 cm 20 pcs.
917	<b>2864</b>	2 pcs. 60 cm suspensions	Alu/silver	138 x 190 cm	Ø 45 cm	18 kg	80 x 120 x 220 cm 20 pcs.
917	<b>2865</b>	2 pcs. 70 cm suspensions	Alu/silver	158 x 190 cm	Ø 45 cm	19 kg	80 x 120 x 220 cm 20 pcs.

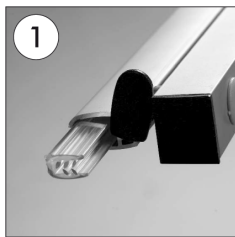

- Slide off the PVC profiles after turning the end caps.
- Die Endkappen der Poster profile abnehmen und PVC profil herausziehen.

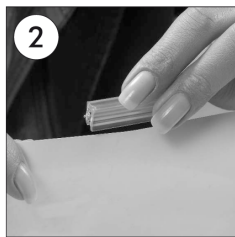

- Slide the PVC profiles through the top & bottom sides of the poster.
- PVC profile in gleichen Abständen an die oberen und unteren seiten anbringen.

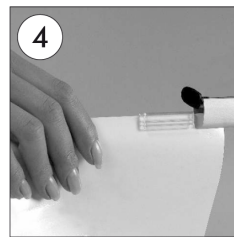
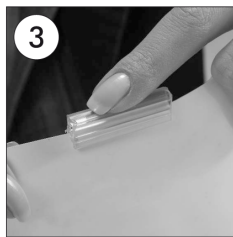

- Slide the poster through the all profile.
- Das Poster dann in das profil hineinstecken.

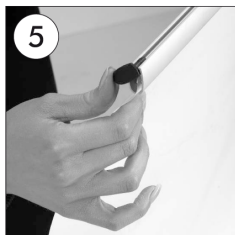

- Close the end caps of all profile.
- Die Endkappen anbringen.



- Slide the square profile notch through the channel of the pole.
- Den Zahn am Vierkantprofil in den Kanal am Mast hineinstecken.



- Fix the banner box profile on desired position on the pole by allen key.
- In der Wunschköhe mit Inbusschlüssel festziehen.

