

 Anodized aluminum stand with 8 pcs. slanting A4 polycarbonate brochure holders. For indoor use.

 Eloxiertes Aluminium Ständer mit 8 Stück A4 Prospekthalter, schräg, aus Polycarbonat hergestellt. Für den Innenbereich.

 Eloxeret aluminiumsstander med 8 stk. skrå A4 polycarbonat brochureholdere. Til indendørs brug.

FOR INDOOR USE!

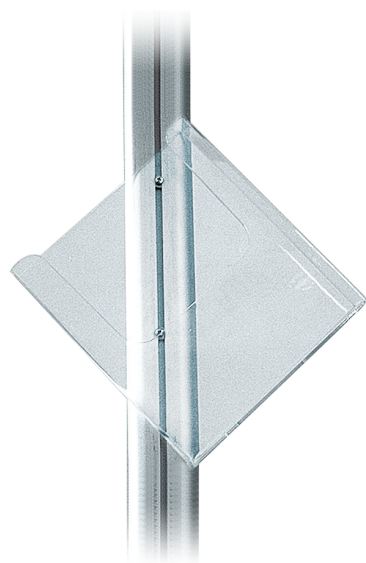

8 x A4 brochure holders

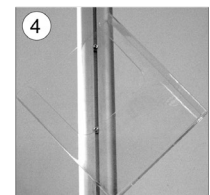
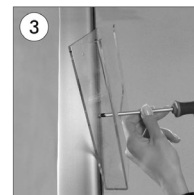
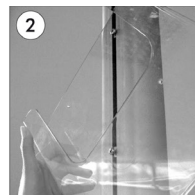
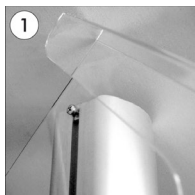
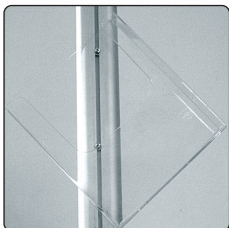
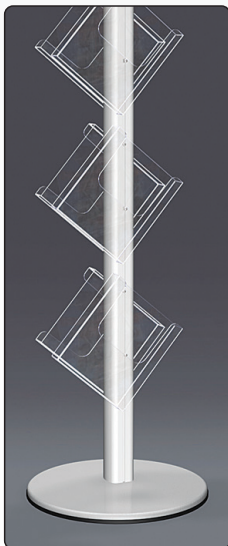
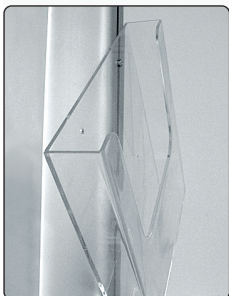
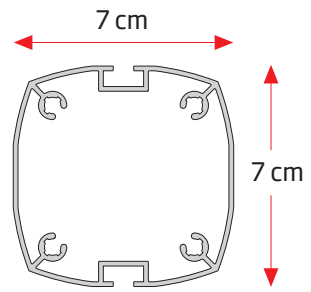
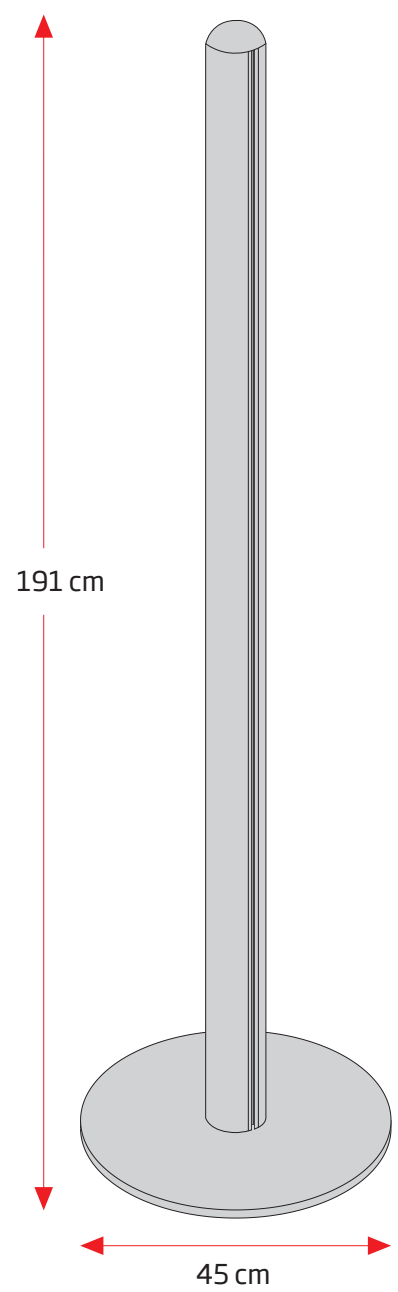

• Slide the connectors of the transparent shelves through the pole channel.
• Mutter an der transparenten Ablage in de Kanal am Mast durchstecken

• Place the transparent shelf on desired position by fixing the connectors.
• An der Wunschhöhe durch Schrauben an den Ablage fest ziehen.

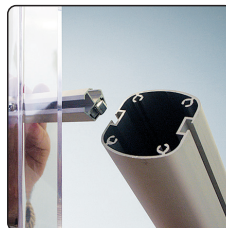

Model	Article	Capacity	Color	Total W x H	Base	Weight	Pallet size and quantity
922	2876	8 x A4	Alu / Acrylic	45 x 190 cm	Ø 45 cm	25 kg	80 x 120 x 220 cm 20 pcs.